



Metal processing Professional and reliable



MANNESMANN DEMAG compressed air tools have been meeting industry's requirements for many years. They offer excellent reliability and power. Our products guarantee:

- Precise working under load conditions
- The appropriate compressed air tool for every application, whether it be a
 - grinding or milling machine
 - vertical grinder, belt grinder
 - filing machine, engraving pen, jig saw
 - angle grinding machine
- Safety lever valve (H) according to EN 792
- Alternative model: rotary valve (D)
- Insulating handle
- Exhaust air to rear via hose unit with integrated silencer
- Modular system enables parts to be exchanged if several models are being used
- Absolutely easy to service
- Low air consumption
- Low noise level
- Accessories program for long life, precision and product quality

MANNESMANN DEMAG compressed air tools are ideal partners for grinding, milling, roughing, filing, engraving and cutting-off operations.



→ Robust and high performance – quality products for metal processing by MANNESMANN DEMAG

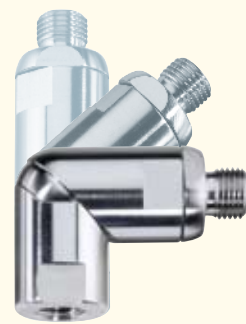

For more flexibility with Variacor® *see page 138*

Oil-free turbine grinding machines

For excellent finishing

65 000 – 100 000 rpm

- High speed for excellent finishing quality
- Easy to service
- High true running accuracy for long term endurance
- Ball bearings with floating support to reduce wear of the rotary burrs
- Non-lubricated use



1



2



3

Technical data

Type		GTV 1000	GT 652 D	GTK 652 D
Order No.		29907-55-5	29940-37-5	29944-57-5
Illustration		2	3	1
Valve		rotary valve	rotary valve	rotary valve
Free speed	rpm	100 000	65 000	65 000
Power	Watt	100	70	70
Exhaust air		to the front	to the rear	to the rear
Discharge brake		—	yes	yes
Spindle front support		flexible	flexible	flexible
Collet included	mm	3	3	3
Carbide rotary burrs max.	mm	3	4	4
Mounted points max.	mm	5	6	6
Noise level	dB(A)	70	65 – 67	65 – 67
Air consumption	l / sec	5.3	3.5	3.5
Weight without hose	kg	0.21	0.27	0.27
Ø machine	mm	30	17	22
Machine length	mm	120	173	135
Hose unit		included	included	included
Supply air hose	m	1.5	1.5	1.5
Exhaust air hose	m	—	1	1
Connection		hose insert nozzle	hose insert nozzle	hose insert nozzle
Accessories supplied		wrench	wrench	wrench

Power and free speed at 6 bar operating pressure. Compressed air quality: oil-free.

Collets



Clamp. range Ø (mm ")	1.0	1.5	2.0	2.5	3.0	1/8"	3/32"
All types	9 369 912	9 369 913	9 369 914	9 369 915	9 369 825	9 369 917	9 369 916

- Ergonomic design
- Especially for fine milling, grinding, engraving and polishing tasks
- Exhaust air to rear via hose unit with integrated silencer
- Classics among the small grinders

High-speed grinding machines

For light deburring work

55 000 – 80 000 rpm



Technical data

		NEW		NEW	
Type		G 803 D	G 803 H	G 551 D	GK 551 D
Order No.		60018-23-5	60018-24-5	29939-85-5	29939-86-5
Illustration		1	2	1	3
Valve		Drehventil	Hebelventil	Drehventil	Drehventil
Free speed	rpm	80 000	80 000	55 000	55 000
Power	Watt	100	100	100	100
Exhaust air		to the rear	to the rear	to the rear	to the rear
Collet included	mm	3	3	3	3
Carbide rotary burrs max.	mm	4	4	6	6
Mounted points max.	mm	6	6	8	8
Noise level	dB(A)	76	76	74	74
Air consumption	l / sec	2	2	2	2
Weight without hose	kg	0.15	0.18	0.15	0.12
Ømaschine	mm	14	14	14	14
Machine length	mm	120	120	120	100
Hose unit		inclusive	inclusive	inclusive	inclusive
Supply air hose	m	1.5	1.5	1.5	1.5
Exhaust air hose	m	1	1	1	1
Connection		plug-in socket	plug-in socket	plug-in socket	plug-in socket
Accessories supplied		wrench	wrench	wrench	wrench

Power and free speed at 6 bar operating pressure. Compressed air quality: oiled.

Collets



Clamp. range Ø (mm ")	1.0	1.5	2.0	2.5	3.0	1/8"	3/32"
All types	9 369 912	9 369 913	9 369 914	9 369 915	9 369 825	9 369 917	9 369 916

Grinding machines

For light deburring work

45 000 rpm

- Ergonomic design
- Exhaust air to rear via hose unit with integrated silencer
- Safety lever valve according to EN 792
- Easy to service
- Powerful vane motor
- G 456 D/H: floating support for excellent and smooth surface finishing



G 456 D



G 452 D

Technical data

Type		G 456 D	G 456 H	G 452 D	G 452 H
Order No.		29946-71-5	29946-72-5	60002-04-5	60002-05-5
Valve		rotary valve	lever valve	rotary valve	lever valve
Free speed	rpm	45 000	45 000	45 000	45 000
Power	Watt	240	240	180	180
Exhaust air		to the rear	to the rear	to the rear	to the rear
Collet included	mm	6	6	6	6
Carbide rotary burrs max.	mm	8	8	8	8
Mounted points max.	mm	10	10	10	10
Noise level	dB(A)	76	76	76	76
Air consumption	l/sec	8.5	8.5	7.5	7.5
Weight without hose	kg	0.50	0.50	0.35	0.35
Ø machine	mm	36	36	30	30
Machine length	mm	167	167	171	171
Hose unit		inclusive	inclusive	inclusive	inclusive
Supply air hose	m	2.5	2.5	2.5	2.5
Exhaust air hose	m	1	1	1	1
Connection thread		G 1/4"	G 1/4"	G 1/4"	G 1/4"
Accessories supplied		wrench	wrench	wrench	wrench

Power and free speed at 6 bar operating pressure. Compressed air quality: oiled.

Collets

Clamp. range Ø (mm)	3.0	4.0	5.0	6.0	8.0
G 456 D G 456 H	9 369 983	—	—	9 369 918	—
All other types	9 369 841	9 369 846	9 369 847	9 369 826	9 369 843



G 452 H

- Ergonomic design
- Exhaust air to rear via hose unit with integrated silencer
- Safety lever valve according to EN 792
- Easy to service
- Powerful vane motor
- G 356 D/H: floating support for excellent and smooth surface finishing

Grinding machines

For light deburring work

35 000 rpm

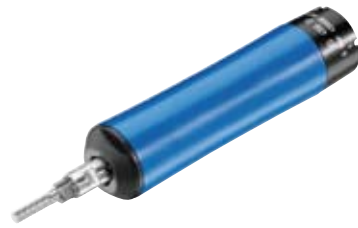

G 356 D



G 356 H



G 352 D

Technical data

Type		G 356 D	G 356 H	G 352 D	G 352 H
Order No.		60010-05-5	60010-04-5	29946-06-5	29946-07-5
Valve		rotary valve	lever valve	rotary valve	lever valve
Free speed	rpm	35 000	35 000	35 000	35 000
Power	Watt	290	290	290	290
Exhaust air		to the rear	to the rear	to the rear	to the rear
Collet included	mm	6	6	6	6
Carbide rotary burrs max.	mm	10	10	10	10
Mounted points max.	mm	16	16	16	16
Noise level	dB(A)	73	73	73	73
Air consumption	l/sec	7.5	7.5	7.5	7.5
Weight without hose	kg	0.50	0.50	0.36	0.36
Ø machine	mm	36	36	30	30
Machine length	mm	170	170	171	171
Hose unit		inclusive	inclusive	inclusive	inclusive
Supply air hose	m	2.5	2.5	2.5	2.5
Exhaust air hose	m	1	1	1	1
Connection thread		G 1/4"	G 1/4"	G 1/4"	G 1/4"
Accessories supplied		wrench	wrench	wrench	wrench

Power and free speed at 6 bar operating pressure. Compressed air quality: oiled.

Collets

Clamp. range Ø (mm)	3.0	4.0	5.0	6.0	8.0
All types	9 369 841	9 369 846	9 369 847	9 369 826	9 369 843



G 352 H

Grinding machines

For light deburring work

28 000 – 30 000 rpm

- Ergonomic design
- Exhaust air to rear via hose unit with integrated silencer
- Safety lever valve according to EN 792
- Easy to service
- Powerful vane motor



G 300 D



G 300 H



GK 282 D



GK 282 H

Technical data

Type		G 300 D	G 300 H	GK 282 D	GK 282 H
Order No.		29923-37-5	29923-38-5	29938-01-5	29938-02-5
Valve		rotary valve	lever valve	rotary valve	lever valve
Free speed	rpm	30 000	30 000	28 000	28 000
Power	Watt	220	220	240	240
Exhaust air		to the rear	to the rear	to the rear	to the rear
Collet included	mm	6	6	6	6
Carbide rotary burrs max.	mm	10	10	10	10
Mounted points max.	mm	16	16	16	16
Noise level	dB(A)	70	70	67	67
Air consumption	l/sec	6.9	6.9	6.6	6.6
Weight without hose	kg	0.45	0.45	0.33	0.33
Ø machine	mm	30	30	30	30
Machine length	mm	207	207	141	141
Hose unit		included	included	included	included
Supply air hose	m	2.5	2.5	2.5	2.5
Exhaust air hose	m	1	1	1	1
Connection thread		G 1/4"	G 1/4"	G 1/4"	G 1/4"
Accessories supplied		wrench	wrench	wrench	wrench

Power and free speed at 6 bar operating pressure. Compressed air quality: oiled.



Collets

Clamp. range Ø (mm)	3.0	6.0
G 300 D/H	9 369 983	9 369 918
GK 282 D/H	9 369 983	9 369 918

Grinding machines

For heavy roughing work

12 000 – 28 000 rpm

Ideal for rough usage

- Highly precise milling, grinding, roughing und deburring
- Exhaust air to rear via hose unit with integrated silencer
- Safety lever valve according to EN 792
- Suitable for two handed use (G 201 H)



Technical data

Type		G 283 H	G 232 H	G 201 H	G 120 H
Order No.		29945-68-5	29935-25-5	60000-29-5	60000-96-5
Illustration		1	1	2	1
Valve		lever valve	lever valve	lever valve	lever valve
Free speed	min ⁻¹	28 000	23 000	20 000	12 000
Power	Watt	400	440	440	400
Exhaust air		to the rear	to the rear	to the rear	to the rear
Collet included	mm	6	6	6	6
Carbide rotary burrs max.	mm	10	12	12	12
Mounted points max.	mm	16	24	32	32
Noise level	dB(A)	76	76	74	74
Air consumption	l/sec	7.5	12.0	12.0	12.0
Weight without hose	kg	0.88	0.74	1.10	0.88
Ø machine	mm	39	39	39	39
Machine length	mm	180	180	280	205
Hose unit		inclusive	inclusive	inclusive	inclusive
Supply air hose	m	2.5	2.5	2.5	2.5
Exhaust air hose	m	1.5	1.5	1.5	1.5
Connection thread		G 1/4"	G 1/4"	G 1/4"	G 1/4"
Accessories supplied		wrench	wrench	wrench	wrench

Power and free speed at 6 bar operating pressure. Compressed air quality: oiled.

Collets



Clamp. range Ø (mm ")	3.0	6.0	8.0	10.0	1/4"
All types	9 369 985	9 369 837	9 369 818	9 369 817	9 369 987

Grinding machines

For heavy roughing work

12 000 – 20 000 rpm

– Types G 16 000 H and G 12 000 H:
Powerful machines with centrifugal governor



G 17000 HV

G 16000 H | G 12000 H

GL 200 H

Technical data

					NEW	NEW
Type		GL 200 H	GL 200 HV	G 17000 HV	G 16000 H	G 12000 H
Order No.		60000-27-5	60000-28-5	29931-58-5	60018-43-5	60018-46-5
Valve		lever valve	lever valve	lever valve	lever valve	lever valve
Free speed	min ⁻¹	20 000	20 000	17 000	16 000	12 000
Power	Watt	400	400	750	1 000	900
Exhaust air		to the rear	to the front	to the front	to the rear	to the rear
Collet included	mm	6	6	8	6	6
Carbide rotary burrs max.	mm	12	12	15	16	16
Mounted points max.	mm	20	20	30	35	50
Noise level	dB(A)	84	84	88	79	79
Air consumption Leer Last	l/sec	12,0	12,0	15,5	13 20	13 20
Weight without hose	kg	1.20	1.20	1.55	1.14	1.14
Ø machine	mm	39	39	46	46	46
Machine length	mm	382	382	327	236	236
Hose unit		inclusive	—	—	inclusive	inclusive
Supply air hose	m	2.5			2.5	2.5
Exhaust air hose	m	1.5			1.0	1.0
Schlauch l. W.	mm	—	8	10	—	—
Connection thread		G 1/4"	G 1/4" i	G 3/8" i	G 3/8"	G 3/8"
Accessories supplied		wrench	wrench	wrench	wrench	wrench

Power and free speed at 6 bar operating pressure. Compressed air quality: oiled.

Collets



Clamp. range Ø (mm ")	3.0	6.0	8.0	10.0	1/4"
GL 200 H HV	9 369 983	9 369 891	—	—	—
G 17000 H HV	9 369 985	9 369 837	9 369 818	9 369 817	9 369 987
G 16000 H, G 12000 H	9 369 855	9 369 839	9 369 842	9 369 852	—

Multifunctional tools

- Inclusive adapter DIN M10 x 30 to connect to flexible shafts (see page 14: types GLA)
- Inclusive rebuild set to G 16 000 H and G 12 000 H
- Powerful machines with centrifugal governor
- Extensions up to 1000 mm

Grinding machines Multifunctional 12 000 – 16 000 rpm



GL 16000 H | GL 12000 H

Technical data

		NEW	NEW
Type		GL 16000 H	GL 12000 H
Order No.		60018-44-5	60018-47-5
Valve		lever valve	lever valve
Free speed	min ⁻¹	16 000	12 000
Power	Watt	1 000	900
Exhaust air		to the rear	to the rear
Collet included	mm	6	6
Carbide rotary burrs max.	mm	16	16
Mounted points max.	mm	35	50
Noise level	dB(A)	79	79
Air consumption Leer Last	l / sec	13 20	13 20
Weight without hose	kg	1.94	1.94
Ø machine	mm	46	46
Machine length	mm	475	475
Hose unit		inclusive	inclusive
Supply air hose	m	2.5	2.5
Exhaust air hose	m	1.0	1.0
Connection thread		G 3/8"	G 3/8"
Accessories supplied		wrench	wrench

Power and free speed at 6 bar operating pressure. Compressed air quality: oiled.

Extensions

Extension (mm)	100	200
Ø shaft 24.5 mm	600 098 15	600 098 45

Further extensions available on request!

Collets

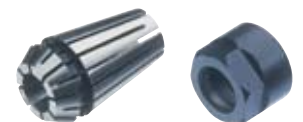

Clamp. range Ø (mm)	6.0	8.0
GL GLA 16000 H	9 369 839	9 369 842
GL GLA 12000 H		
Nut	29701-56-3	29701-56-3

Grinding machines

Variable extension

12 000 – 16 000 rpm



GLA 16000 H | GLA 12000 H

Extension

New Product Line!

- Variable extensions in straight or angle version with DIN Adapter M10 × 30 to connect flexible shafts
- Powerful machines with centrifugal governor
- **Free combination of extensions and handpieces**

Technical data

		NEU	NEU
Type		GLA 16000 H	GLA 12000 H
Order No.		60018-45-5	60018-48-5
Valve		lever valve	lever valve
Free speed	rpm	16 000	12 000
Power	Watt	1 000	900
Exhaust air		to the rear	to the rear
Collet included	mm	6	6
Carbide rotary burrs max.	mm	16	16
Mounted points max.	mm	35	50
Noise level	dB(A)	79	79
Air consumption Leer Last	l / sec	13 20	13 20
Weight without hose	kg	1.25	1.25
Ø machine	mm	46	46
Machine length	mm	256	256
Hose unit		inclusive	inclusive
Supply air hose	m	2.5	2.5
Exhaust air hose	m	1.0	1.0
Connection thread		G 3/8"	G 3/8"
Accessories supplied		wrench	wrench

Power and free speed at 6 bar operating pressure. Compressed air quality: oiled.



Handpiece straight, 90°, 45°

Extensions for connection DIN M10 × 30

Extension (mm)	250	500
Ø Shaft 33 mm	60018-93-6	60018-94-6

Handpieces for extensions, Connection G 28

Form		Straiht	Angle 90°	Angle 45°
Order No.		60018-92-6	60018-95-6	60018-96-6
Ø × Length	mm	33 × 162	55 × 156	57 × 184
Collet	mm	8	6	6
Weight	kg	0,51	0,81	0,85

Collets

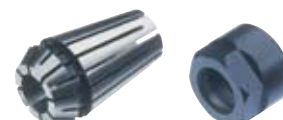

Clamp. range Ø (mm)	6.0	8.0	10.0
Handpiece straight	9 369 935	9 369 936	9 369 937
Handpiece 90°, 45°	9 369 918	—	—

Grinding machines

With extension

10 000 rpm

- Comfortable use by a safety valve embedded into the hand grip
- Ideally for internal grinding, deburring of hollow spaces (e.g. motor blocks, tubes, turbine blades) and for finishing welding lines
- Robust extensions with easy changing
- Max. neck extension length up to 1000 mm ensure working in difficult to access areas
- Spindle with threaded connection M12 for mounted points and carbide burrs
- Built in speed governor keeps the revolutions on load nearly constant



G 100 H

Technical data

Type with collet Ø 6 mm		G 100 H	G 100 H-100	G 100 H-200	G 100 H-400	G 100 H-500
Order No.		60009-35-5	60009-36-5	60009-37-5	60009-38-5	60009-39-5
Type with thread M12		G 101 H	G 101 H-100	G 101 H-200	G 101 H-400	G 101 H-500
Order No.		60009-40-5	60009-41-5	60009-42-5	60009-43-5	60009-44-5
With Extension	mm	—	100	200	400	500
Free speed	rpm	10 000	10 000	10 000	10 000	10 000
Power	Watt	1 300	1 300	1 300	1 300	1 300
Exhaust air		to the side	to the side	to the side	to the side	to the side
Carbide rotary burrs max.	mm	16	16	16	16	16
Mounted points max.	mm	50	50	50	50	50
Flap wheels max.	mm	60	60	60	60	60
Noise level	dB(A)	89	89	89	89	89
Air consumption Leer Last	l / sec	11.7 27.7	11.7 27.7	11.7 27.7	11.7 27.7	11.7 27.7
Weight without hose	kg	3.2	3.5	3.8	4.4	4.7
Ø machine	mm	65	65	65	65	65
Machine length G 100 H G 101 H	mm	523 508	623 608	723 708	923 808	1 023 1 008
Air supply hose	m	2.5	2.5	2.5	2.5	2.5
Hose I.D.	mm	13	13	13	13	13
Connection thread		G 1/2"	G 1/2"	G 1/2"	G 1/2"	G 1/2"
Accessories supplied		wrench	wrench	wrench	wrench	wrench

Power and free speed at 6 bar operating pressure. Compressed air quality: oiled.

Extensions

Extension (mm)	100	200
Ø Shaft 24.5 mm	600 098 15	600 098 45
Further extensions available on request!		

Collets

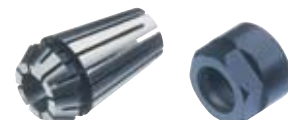

Clamp. range Ø (mm)	6.0	8.0
G 100 H	9 369 839	9 369 842
Nut	29701-56-3	29701-56-3

Grinding machines

Dimensions (mm)

GL 200 H and GL 200 HV

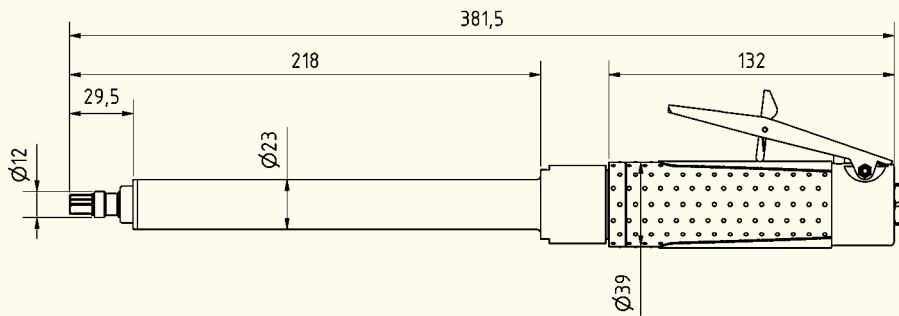

G 16000 H and G 12000 H

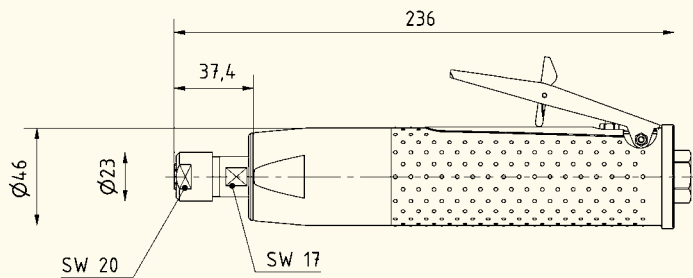

GL 16000 H and GL 12000 H

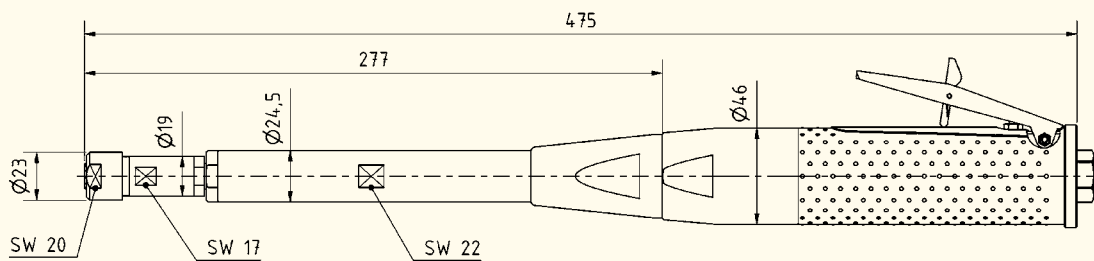

GLA 16000 H and GLA 12000 H

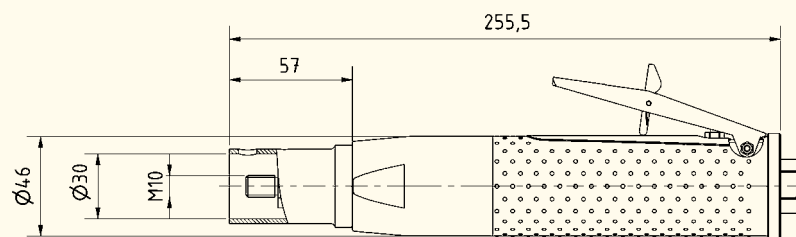

Grinding machines

Dimensions (mm)

G 100 H

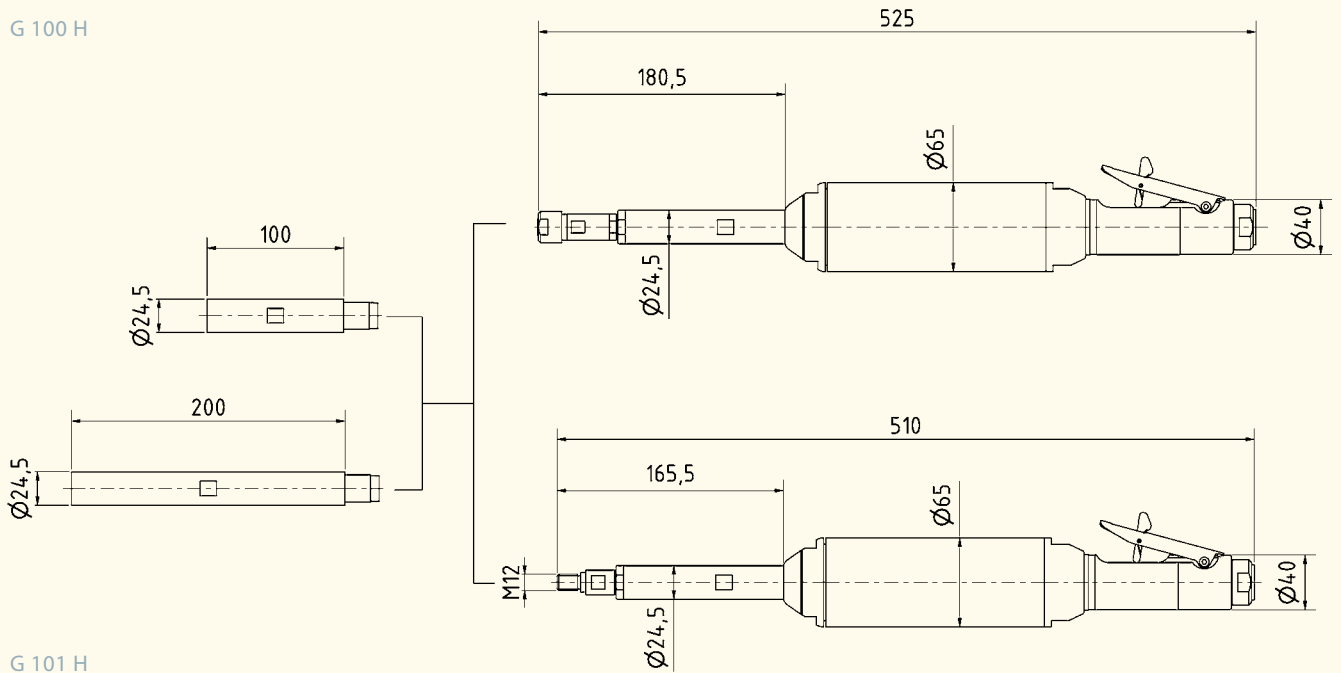

G 101 H



Grinding machines

Exhaust air to the front

28 000 rpm

- Highly precise milling, grinding, roughing and deburring
- High performance and robust
- Safety lever valve according to EN 792
- For light deburring work



GK 282 DV



GK 282 HV



G 281 DV

Technical data

Type		GK 282 DV	GK 282 HV	G 281 DV
Order No.		29938-11-5	29938-12-5	29908-32-5
Valve		rotary valve	lever valve	rotary valve
Free speed	rpm	28 000	28 000	28 000
Power	Watt	240	240	220
Exhaust air		to the front	to the front	to the front
Collet included	mm	6	6	6
Carbide rotary burrs max.	mm	10	10	10
Mounted points max.	mm	16	16	16
Noise level	dB(A)	78	78	79
Air consumption	l/sec	7.5	7.5	5.6
Weight without hose	kg	0.30	0.30	0.41
Ø machine	mm	31	31	30
Machine length	mm	143	143	196
Hose I. D.	mm	8	8	8
Connection		G 1/4" i	G 1/4" i	G 1/4" i
Accessories supplied		wrench	wrench	wrench

Power and free speed at 6 bar operating pressure. Compressed air quality: oiled.

Collets

Clamp. range Ø (mm)	3.0	6.0
GK 282 DV/HV	9 369 983	9 369 918
G 281 DV	9 369 983	9 369 918



Swivel joint

Variacor	60001-60-6
-----------------	------------

Further Information see p. 138

- Highly precise milling, grinding, roughing und deburring
- High performance and robust
- Safety lever valve according to EN 792
- G 281 HV for light deburring work
- G 201 HV for two-handed use

Grinding machines

Exhaust air to the front

20 000 – 28 000 rpm



G 281 HV

GK 201 HV

G 201 HV

Technical data

Type		G 281 HV	GK 201 HV	G 201 HV
Order No.		29908-33-5	60001-45-5	60000-30-5
Valve		lever valve	lever valve	lever valve
Free speed	rpm	28 000	20 000	20 000
Power	Watt	220	440	440
Exhaust air		to the front	to the front	to the front
Collet included	mm	6	6	6
Carbide rotary burrs max.	mm	10	12	12
Mounted points max.	mm	16	32	32
Noise level	dB(A)	79	85	84
Air consumption	l/sec	5.6	12.0	12.0
Weight without hose	kg	0.41	0.95	1.05
Ø machine	mm	30	39	39
Machine length	mm	197	180	280
Hose I.D.	mm	8	8	8
Connection		G 1/4" i	G 1/4" i	G 1/4" i
Accessories supplied		wrench	wrench	wrench

Power and free speed at 6 bar operating pressure. Compressed air quality: oiled.

Collets

Clamp. range Ø (mm ")	3.0	6.0	8.0	10.0	1/4"
G 281 HV	9 369 983	9 369 918	—	—	—
GK 201 HV and G 201 HV	9 369 985	9 369 837	9 369 818	9 369 817	9 369 987



Swivel joint

Variacor 60001-60-6

Further Information see p. 138

Angle grinding machines

With collet

- For Deburring, grinding, milling, polishing and cast cleaning
- GW 218 H/HV with angle head of steel
- Robust finishings, ER-collet
- GW 216 H with angle head of aluminium
- Safety lever valve according to EN 792
- Robust model
- Optimized gear support for a high torque



GW 216 H, GW 126 H



GW 218 H



GW 218 HV

Technical data

Type		GW 216 H	GW 218 H	GW 218 HV	GW 126 H
Order No.		29935-62-5	29934-69-5	29934-82-5	60001-19-5
Valve		lever valve	lever valve	lever valve	lever valve
Free speed	rpm	20 000	20 000	20 000	12 000
Power	Watt	350	350	350	350
Exhaust air		to the rear	to the rear	to the front	to the rear
Collet included	mm	6	6	6	6
Carbide rotary burrs max.	mm	12	12	12	12
Mounted points max.	mm	24	24	24	24
Grinding wheel max.	mm	75	75	75	75
Noise level	dB(A)	74	74	88	88
Air consumption	l/sec	10.0	10.0	13.3	13.3
Weight without hose	kg	1,00	1.15	1.15	1.00
Machine height	mm	67.3	76.0	76.0	68.0
Machine length	mm	150	150	167	174
Hose I.D.	mm	—	—	8	—
Hose unit		inclusive	inclusive		inclusive
Supply air hose	m	2.5	2.5	—	2.5
Exhaust air hose	m	1.5	1.5	—	1.5
Connection		external thread R 1/4"	external thread R 1/4"	R 1/4" i	external thread R 1/4"
Accessories supplied		wrench	wrench	wrench	wrench

Power and free speed at 6 bar operating pressure. Compressed air quality: oiled.



Collets

Clamp. range Ø (mm)		3.0	6.0	8.0
GW 216 H	ER 11	9 369 853	9 369 832	—
GW 218 H and HV	ER 16	9 369 855	9 369 839	9 369 842

Angle grinding machines

With collet

Combidisc for GW 216 H, GW 218 H, GW 218 HV and GW 126 H

For the professional treatment of surfaces, radii or outlines

A 01	1 holder, \varnothing 50 mm	Order No. 9368 610
A 02	10 grinding discs, \varnothing 50 mm, grain 36	Order No. 9368 614
A 03	10 grinding discs, \varnothing 50 mm, grain 60	Order No. 9368 615
A 04	10 grinding discs, \varnothing 50 mm, grain 120	Order No. 9368 616
B 01	1 holder, \varnothing 50 mm	Order No. 9368 611
B 02	10 grinding discs, \varnothing 50 mm, grain 60	Order No. 9368 612
B 03	10 grinding discs, \varnothing 50 mm, grain 120	Order No. 9368 613

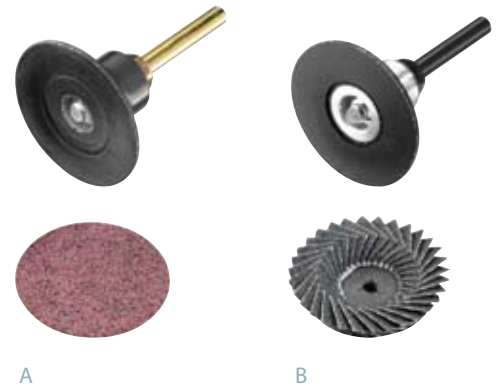

GW 216 H | GW 126 H dimensions (mm)

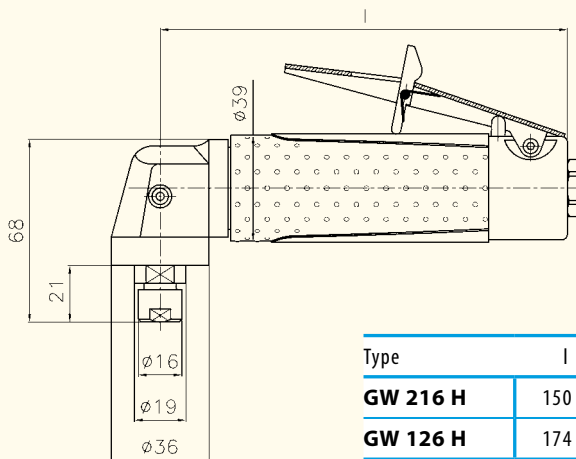

GW 218 HV | GW 218 H dimensions (mm)

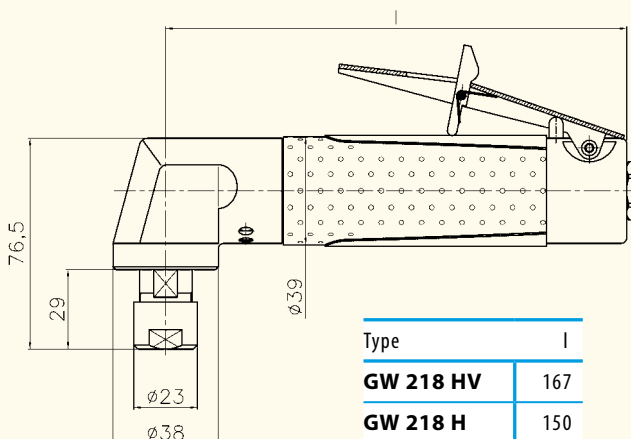

Angle grinding machines

Roughing, grinding and polishing

For fibre-reinforced grinding discs or for use with elastic rubber discs



1

2

- Type GW 122 H:
 - direct drive without angular gearing
- Easy to service
- Additional handle may be fitted on either side
- Safety lever valve according to EN 792
- Type GW 121 H:
 - with centrifugal governor, automatic out-of-balance compensation
- Low angle head height
- Dust extraction system upon request

Technical data

Type		GW 122 H	GW 121 H
Order No.		60016-98-5	60012-07-5
Illustration		1	2
Valve		lever valve	lever valve
Free speed	rpm	12 000	12 000
Power	Watt	750	1 100
Exhaust air		to the rear	to the rear
Spindle thread		M 14	M 14
Grinding wheel max.	mm	125	125
Noise level	dB(A)	82	83
Air consumption	l/ sec	14.0	15.0
Weight without hose	kg	1.80	2.10
Machine height	mm	108	98
Machine length	mm	203	240
Hose I. D.	mm	9	—
Hose unit			inklusive
Supply air hose	m	—	2.5
Exhaust air hose	m	—	1.0
Connection		G 3/8" i	G 3/8"
Accessories supplied		wrench, side handle	wrench, side handle

Power and free speed at 6 bar operating pressure. Compressed air quality: oiled.



Accessories

For Type		GW 122 H	GW 121 H
Hose unit		60017-38-5	60012-09-5
Rubber plate		9 368 202	9 368 202
Fibre	Grain 36	9 368 009	9 368 009
	Grain 60	9 368 224	9 368 224
	Grain 80	9 368 010	9 368 010
Fettling wheel		9 368 603	9 368 603

Hose unit: incl. supply / exhaust air hose.

Vertical grinding machines

For heavy-duty applications

- Suitable for steel erection, machine-building, reinforced concrete construction, foundries etc.
- For the cutting-off of steel, castings, wire ropes, artificial flags etc.
- For roughing, grinding and burnishing of all types of metal
- For removing rust and paint with cup brushes
- GV 84-1 vibration damped
- Safety lever valve
- GV 66-1 with automatic imbalance compensation, which reduces vibration to a minimum



GV 84-1



GV 66-1

Technical data

Type		GV 84-1	GV 66-1
Order No.		03250-03-5	29900-36-6
Valve		lever valve	lever valve
Free speed	rpm	8 500	6 600
Power	Watt	1 800	2 350
Exhaust air		to the side	to the side
Spindle thread		5/8"	M 14
Grinding wheel max.	mm	178	230
Noise level	dB(A)	78	84
Air consumption	l/sec	25.0	33.5
Weight without hose	kg	3.60	5.60
Machine height	mm	189	200
Machine length	mm	400	335
Hose I. D.	mm	16	16
Connection		G 1/2" i	G 1/2" i
Accessories supplied		wrench for tool change, flange for scrubbing wheels	

Power and free speed at 6 bar operating pressure. Compressed air quality: oiled.

Zubehör



For Type	GV 84-1
Flange set Rubber plate, flanges and wrench	60009-23-6
Rubber plate Ø 178 mm	9 368 201

Swivel joint



Variacor	60001-62-6
Further Information see p. 138	

Belt grinders

For belt length 330 and 610 mm

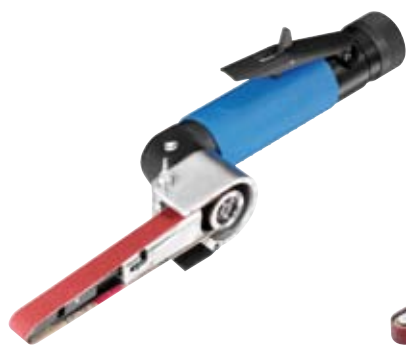

GB 815 H



GB 613 D

GB 815 H

- Sanding arm included
- Powerful motor
- Easy change of belts
- Air to the rear via hose unit included
- Compact design, small weight
- Telescopic belt tension
- Suitable for sanding belts 8 and 15 mm

GB 613 H | D

- To grind on the free belt or grinding arm
- With cooling of belts
- For band width 6 mm and 13 mm
- exchange grinding arms are available

Technical data

Type		GB 815 H	GB 613 H	GB 613 D
Order No.		60010-68-5	60011-75-5	60011-74-5
Free speed	rpm	20 000	20 000	20 000
Power	Watt	350	400	300
Exhaust air		to the rear	to the rear	to the rear
Belt measures	mm	330×8 / 330×15	610×6 / 610×13	610×6 / 610×13
Belt run speed	m / s	20	20	20
Noise level	dB(A)	76	73	73
Air consumption	l / sec	10.0	14.1	14.1
Weight without hose	kg	0.95	1.40	1.40
Machine height	mm	38	116	116
Machine length	mm	295	371	371
Hose I. D.	mm	—	8	8
Hose unit		inclusive	inclusive	inclusive
Supply air hose	m	2.5	2.5	2.5
Exhaust air hose	m	1.5	1.5	1.5
Connection		G 1/4"	G 1/4"	G 1/4"
Accessories supplied		sanding arm	contact arm 11218	contact arm 11218

Power and free speed at 6 bar operating pressure. Compressed air quality: oiled.

Contact arms for GB 613 H | D (mm)

A	11216	Rubber wheel	∅ 16 × 3	L 610 × B 6	Order No. 60011-26-6
B	11219	Rubber wheel	∅ 25 × 9.5	L 610 × B 6	Order No. 60011-27-6
C	11213	Steel wheel	∅ 8 × 9.5	L 610 × B 13	Order No. 60011-28-6
D	11218	Rubber wheel	∅ 16 × 9.5	L 610 × B 13	Order No. 60011-29-6
E	11231	Rubber wheel	∅ 19 × 13	L 610 × B 13	Order No. 60011-30-6

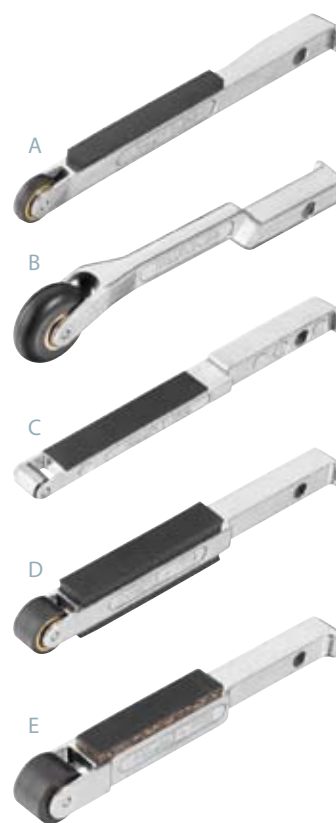

Contact arms

Abrasive belts (10 pieces)

Grain	60	120	180	240
330 × 8 mm	9368 701	9368 702	9368 703	9368 704
330 × 15 mm	9368 711	9368 712	9368 713	9368 714
610 × 6 mm	9368 725	9368 726	9368 727	9368 728
610 × 13 mm	9368 729	9368 730	9368 731	9368 732

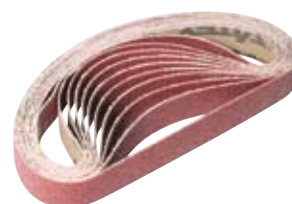

Abrasive belts

Carbide rotary burrs

Precision for maximum performance

Optimum chip flow

Toothing 6 Cross cut

- For hardened steels and materials
- High firmness
- Small splinters



Toothing 6

Toothing 5 Fine cut

- For hardened steels up to 65 HRC to the achievement of fine surfaces



Toothing 5

Toothing 1 Alu cut

- For aluminium alloys, yield non-ferrous metals and plastics
- Large swarf spaces



Toothing 1

Material employment refer.

Toothing	1	5	6
Aluminium	×		
Brass, copper, bronze			×
Glass fiber			×
Cast iron			×
Plastic	×		
Steel > 55 HRC		×	×
Steel > 60 HRC		×	×
Steel			×
Stainless steel		×	×
Nickel alloys			×
Welded parts			×
Titanium		×	×
Zinc	×		

Speed recommendation

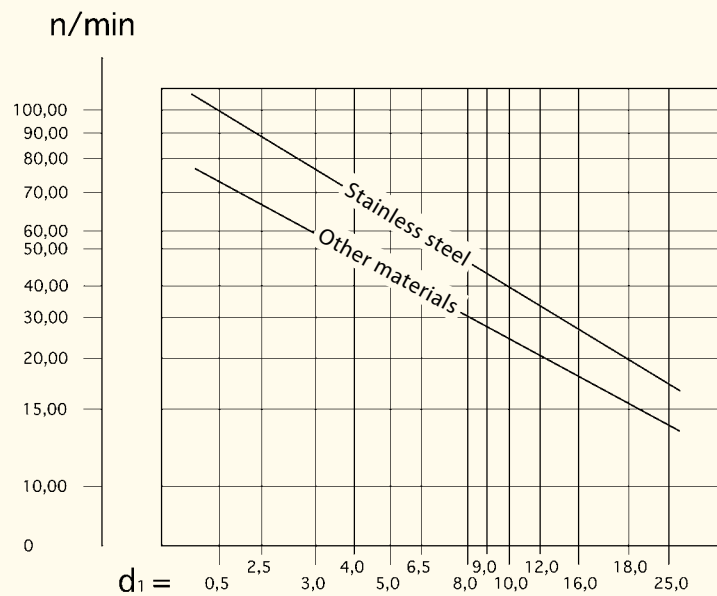

Set of carbide rotary burrs (6 parts)

- 6 different forms
- ZYA, WRC, KUD, RBF, SPG and SKM



∅ shank 3 mm	∅ head 3 mm	toothing 6	Order No. 9 376 861
∅ shank 3 mm	∅ head 3 mm	toothing 5	Order No. 9 376 885
∅ shank 6 mm	∅ head 6/8 mm	toothing 6	Order No. 9 376 862

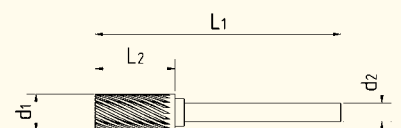

Carbide rotary burrs

ZYA, WRC

Cylinder (ZYA)

Head ∅ mm d1	Head length mm L2	Shank ∅ mm d2	Length total mm	Order No. toothing 6	Order No. toothing 5	Order No. toothing 1
Shank 3 mm						
2	10	3	40	9 376 800	—	—
3	13	3	40	9 376 801	9 376 703	—
6	13	3	40	9 376 802	9 376 705	—
Shank 6 mm						
6	16	6	50	9 376 831	9 376 707	—
8	20	6	60	9 376 832	9 376 709	—
10	20	6	60	9 376 833	9 376 711	9 376 712
12	25	6	65	9 376 834	9 376 713	9 376 890

Cylinder (ZYA) with front tothing

Head ∅ mm d1	Head length mm L2	Shank ∅ mm d2	Length total mm	Order No. toothing 6	Order No. toothing 5	Order No. toothing 1
Shank 3 mm						
3	13	3	40	9 376 820	9 376 721	—
6	13	3	40	9 376 821	9 376 723	—
Shank 6 mm						
10	19	6	63	9 376 725	9 376 726	9 376 727
13	25	6	69	9 376 728	9 376 729	9 376 730

Round nose (WRC)

Head ∅ mm d1	Head length mm L2	Shank ∅ mm d2	Length total mm	Order No. toothing 6	Order No. toothing 5	Order No. toothing 1
Shank 3 mm						
3	13	3	40	9 376 803	9 376 741	—
6	13	3	43	9 376 804	9 376 743	—
Shank 6 mm						
6	16	6	50	9 376 835	9 376 745	—
8	20	6	60	9 376 836	9 376 747	—
10	20	6	60	9 376 837	9 376 749	9 376 750
12	25	6	65	9 376 838	9 376 751	9 376 752

Arch round nose (RBF)

Head ∅ mm d1	Head length mm L2	Shank ∅ mm d2	Length total mm	Order No. toothing 6	Order No. toothing 5	Order No. toothing 1
Shank 3 mm						
3	12	3	40	9 376 812	9 376 755	—
6	13	3	43	9 376 813	9 376 757	—
Shank 6 mm						
6	18	6	50	9 376 850	9 376 759	—
10	20	6	60	9 376 851	9 376 761	9 376 762
12	25	6	65	9 376 852	9 376 763	9 376 894

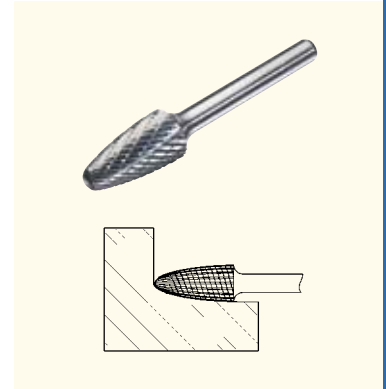

Arch pointed nose (SPG)

Head ∅ mm d1	Head length mm L2	Shank ∅ mm d2	Length total mm	Order No. toothing 6	Order No. toothing 5	Order No. toothing 1
Shank 3 mm						
3	13	3	40	9 376 814	9 376 764	—
6	13	3	43	9 376 819	9 376 815	—
Shank 6 mm						
6	18	6	50	9 376 853	9 376 767	—
8	18	6	58	9 376 854	9 376 897	—
10	20	6	60	9 376 855	9 376 769	—
12	25	6	65	9 376 856	9 376 771	9 376 895

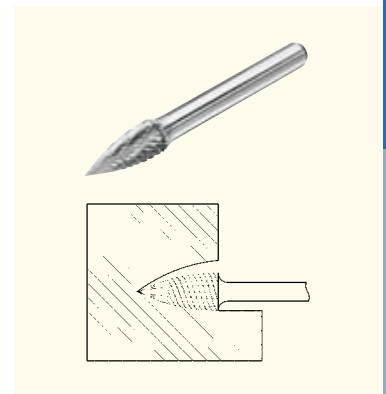

Conical pointed nose (SKM)

Head ∅ mm d1	Head length mm L2	Shank ∅ mm d2	Length total mm	Order No. toothing 6	Order No. toothing 5	Order No. toothing 1
Shank 3 mm						
3	12	3	40	9 376 816	9 376 772	—
6	13	3	43	9 376 817	9 376 774	—
Shank 6 mm						
6	18	6	50	9 376 857	9 376 776	—
10	20	6	60	9 376 858	9 376 778	—
12	25	6	65	9 376 859	9 376 780	9 376 896

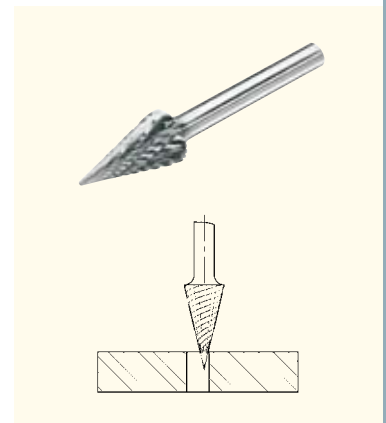

Mounted points

Tool manufacture and mould making

- Grain type: EK blue
- Especially suitable for the working of hardened or alloy steels
- Universal application in finish-grinding operations
- Shank diameter 3 mm

Cylinder

Head Ø mm	Head length mm	Shank Ø mm	Shank length mm	Order No.
2	5	3	30	9 376 950
3	6	3	30	9 376 951
4	8	3	30	9 376 952
5	10	3	30	9 376 953
6	10	3	30	9 376 954
8	10	3	30	9 376 958
10	10	3	30	9 376 959

Spherical

Head Ø mm	Head length mm	Shank Ø mm	Shank length mm	Order No.
3	—	3	30	9 376 955
5	—	3	30	9 376 956
8	—	3	30	9 376 957

Round nose

Head Ø mm	Head length mm	Shank Ø mm	Shank length mm	Order No.
3	6	3	30	9 376 968
5	10	3	30	9 376 962

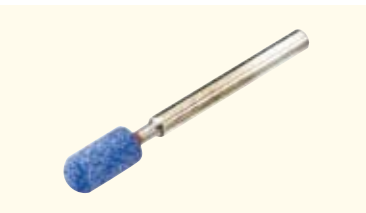
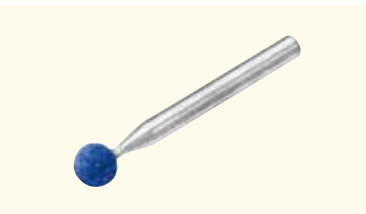
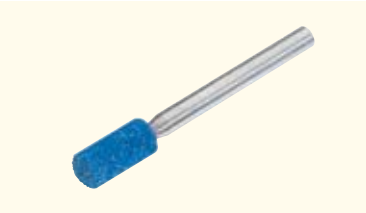

POLICAP

Sharpening caps are predominantly used in the tool manufacture for finishing work on difficult to access areas. They are suitable for the treatment of steel and stainless steel.

Mounted points Tool manufacture and mould making

Arch pointed nose

Head Ø mm	Head length mm	Shank Ø mm	Shank length mm	Order No.
3	6	3	30	9 376 967
5	10	3	30	9 376 960

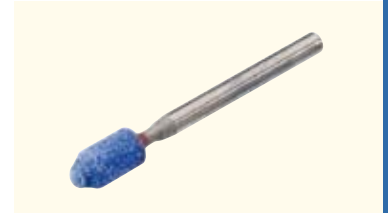

Conical nose

Head Ø mm	Head length mm	Shank Ø mm	Shank length mm	Order No.
5	10	3	30	9 376 961
10	13	3	30	9 376 966



Sharpening cap carrier (5 pieces)

Head Ø mm	Height length mm	Schaft Ø mm	Drehzahl min ⁻¹	Weight kg 5 pieces	Order No.
5	15	6	empf. 40 000	0,050	9 376 971
11	25	6	empf. 20 000	0,060	9 376 972



Sharpening caps (50 pieces)

Grain	60	150	280
Ø 5 mm height 15 mm	—	9 376 974	9 376 975
Ø 11 mm height 25 mm	9 376 976	9 376 977	9 376 978



Set of mounted points (6 parts)

- 3 × 6 cylinder
- 5 × 10 cylinder
- 5 spherical
- 5 × 10 round nose
- 5 × 10 arch pointed nose
- 5 × 10 conical nose



Free speed up to 100 000 rpm Order No. 9 376 965

Hose units



Exemplary representation

Order numbers

For type	Hose unit complete	Supply air hose per running meter	Exhaust air hose per running meter	Thread socket
GT 652 D GTK 652 D	29911-55-5	9 361 532	9 361 214	47092-05-6
GTV 1000	29939-02-5	9 361 213	—	29300-63-6
G 803 D/H	29939-94-5	9 361 213	9 361 212	29939-93-3
G 551 D GK 551 D	29939-94-5	9 361 213	9 361 212	29939-93-3
G 456 D/H G 452 D/H	29923-49-5	9 361 532	9 361 214	47092-05-6
G 356 D/H G 352 D/H	29923-49-5	9 361 532	9 361 214	47092-05-6
G 300 D/H	29923-49-5	9 361 532	9 361 214	47092-05-6
GK 282 D/H	29923-49-5	9 361 532	9 361 214	47092-05-6
G 283 H	29923-33-5	9 361 158	9 361 208	9 361 330
G 232 H G 120 H	29923-33-5	9 361 158	9 361 208	9 361 330
G 201 H	29923-33-5	9 361 158	9 361 208	9 361 330
GL 200 H	29923-33-5	9 361 158	9 361 208	9 361 330
GW 216 GW 218 H GW 126 H	29923-33-5	9 361 158	9 361 208	9 361 330
GB 815 H GB 613 D/H	29923-33-5	9 361 158	9 361 208	9 361 330
GW 122 H	60017-38-5	9 361 158	9 361 192	9 361 330
G 16000 H G 12000 H GL 16000 H GL 12000 H GLA 16000 H GLA 12000 H GW 121 H	60012-09-5	9 361 115	9 361 193	9 361 477

Engraving pen

Writing, engraving and chiselling

- For writing and engraving on hardened steel, metal, glass, plastic, ceramic and stone
- Simple needle change
- Extremely low vibrations level below 2.5 m/s^2
- Noise level below 65 dB(A)
- GST 540 M for chiselling, fossils work



GST 540

Needle

Technical data

Type		GST 540	GST 540 M
Order No.		29903-91-6	29943-71-6
Valve		rotary valve	rotary valve
Frequency	Hz	540	540
Vibration	m/s^2	< 2.5	< 2.5
Noise level	dB(A)	65	65
Air consumption	l/sec	0.85	0.85
Weight without hose	kg	0.15	0.15
Ø machine	mm	17	17
Machine length	mm	162	162
Hose unit		inclusive	inclusive
Hose	m	2.5	2.5
Connection		plug-in socket	plug-in socket
Accessories supplied		needle, medium	chisel insert

Power and free speed at 6 bar operating pressure. Compressed air quality: oiled.

Accessories for GST 540

Needle (tungsten carbide)

fine	29904-13-6
medium	29904-05-6
coarse	29904-14-6

Accessories for GST 540 M

Complete chisel head with chisel	29937-94-6
Complete chisel head with needle	29937-93-6
Chisel with spring	29937-92-6



GST 540 M

Filing machines

Deburring, filing works



FRV 60 B

FRV 110

- Deburring of cast or machined parts
- Filing applications in tool and mould making
- Extremely low vibration:
FRV 110: 2.0 m/s²
FRV 60 B: 1.8 m/s²
- FRV 110 for heavy-duty filing works
- High precision
- Calm run
- For files with round shank

Technical data

Type		FRV 60 B	FRV 110
Order No.		29900-07-6	29701-14-6
Order No.		push button	lever valve
Number of blows	rpm	8 400	9 000
Frequency	Hz	140	150
Stroke max.	mm	4	8
Exhaust air		to the front	to the front
Ø tool holder max.	mm	3 – 4	4 6
Tool holder		clamping bolt	clamping bolt
Noise level	dB(A)	71	77
Air consumption	l/sec	0.5	1.3
Weight without hose	kg	0.30	1.05
Ø machine	mm	30	41
Machine length	mm	200	180
Hose I. D.	mm	—	6
Connection		—	G 1/4" i
Accessories supplied		wrench, Hose 1.5 m	wrench

Power and free speed at 6 bar operating pressure. Compressed air quality: oiled.

Accessories for FRV 110

Reduction collet 6/4 (for shanks 4 mm)	29931-44-6
--	------------



Swivel joint for FRV 110

Variacor	60001-60-6
----------	------------







Further Information see p. 138



Diamond file (detail)





Feilen for FRV 60 B

Ø shank 3.0 mm

Profile						
Cut 1 Order No.		9 376 906	9 376 907	9 376 908	9 376 909	9 376 910
Width × depth	mm	7.0 × 2.0	3.0 × 3.0	4.0 × 4.0	6.5 × 2.0	Ø 3.6
Useable length	mm	60	60	60	60	60
Ø shank	mm	3.0	3.0	3.0	3.0	3.0





Files for FRV 60 B

Ø shank 3.8 mm

Profile						
Cut 1 Order No.		9 376 921	9 376 922	9 376 924	9 376 926	9 376 928
Cut 0 Order No.		9 376 911	9 376 923	9 376 925	9 376 927	9 376 929
Width × depth	mm	7.0 × 2.0	3.0 × 3.0	4.0 × 4.0	6.5 × 2.0	Ø 3.6
Useable length	mm	60	60	60	60	60
Ø shank	mm	3.8	3.8	3.8	3.8	3.8





Diamond files for FRV 60 B

Ø shank 3.0 mm

Profile						
Grain D 107 Order No.		9 376 931	9 376 932	9 376 933	9 376 934	9 376 935
Width × depth	mm	5.2 × 1.4	2.5 × 2.5	3.6 × 3.6	5.0 × 2.0	Ø 3.0
Total length	mm	85	85	85	85	85
Useable length	mm	45	45	45	45	45
Ø shank	mm	3.0	3.0	3.0	3.0	3.0

Files for FRV 110

Ø shank 6.0 mm

Profile						
Cut 1 Order No.		9 376 900	9 376 901	9 376 902	9 376 903	9 376 904
Cut 0 (for alu) Order No.		9 376 912	—	—	—	—
Hieb 1 Width × depth	mm	12.3 × 6.3	8.0 × 8.0	9.0 × 9.0	12.0 × 6.0	Ø 6.0
Hieb 0 Width × depth	mm	12.0 × 7.0	—	—	—	—
Useable length	mm	80	80	80	80	80
Ø shank	mm	6.0	6.0	6.0	6.0	6.0

Air motors

0,11 to 4,4 kW

→ Individual and powerful with alternatives – request our special folder »Air motors« !

